



SERVING HEALTH CARE WORLD WIDE



@surgicalinstrumentssupplies



@uniqueempiresurgical



@unique-empire-b339b51aa



+92 302 6633155



**DENTAL**  
**INSTRUMENTS**

[HTTPS://WWW.UNIQUEEMPIRE.COM/](https://www.uniqueempire.com/)



# Implants Instruments

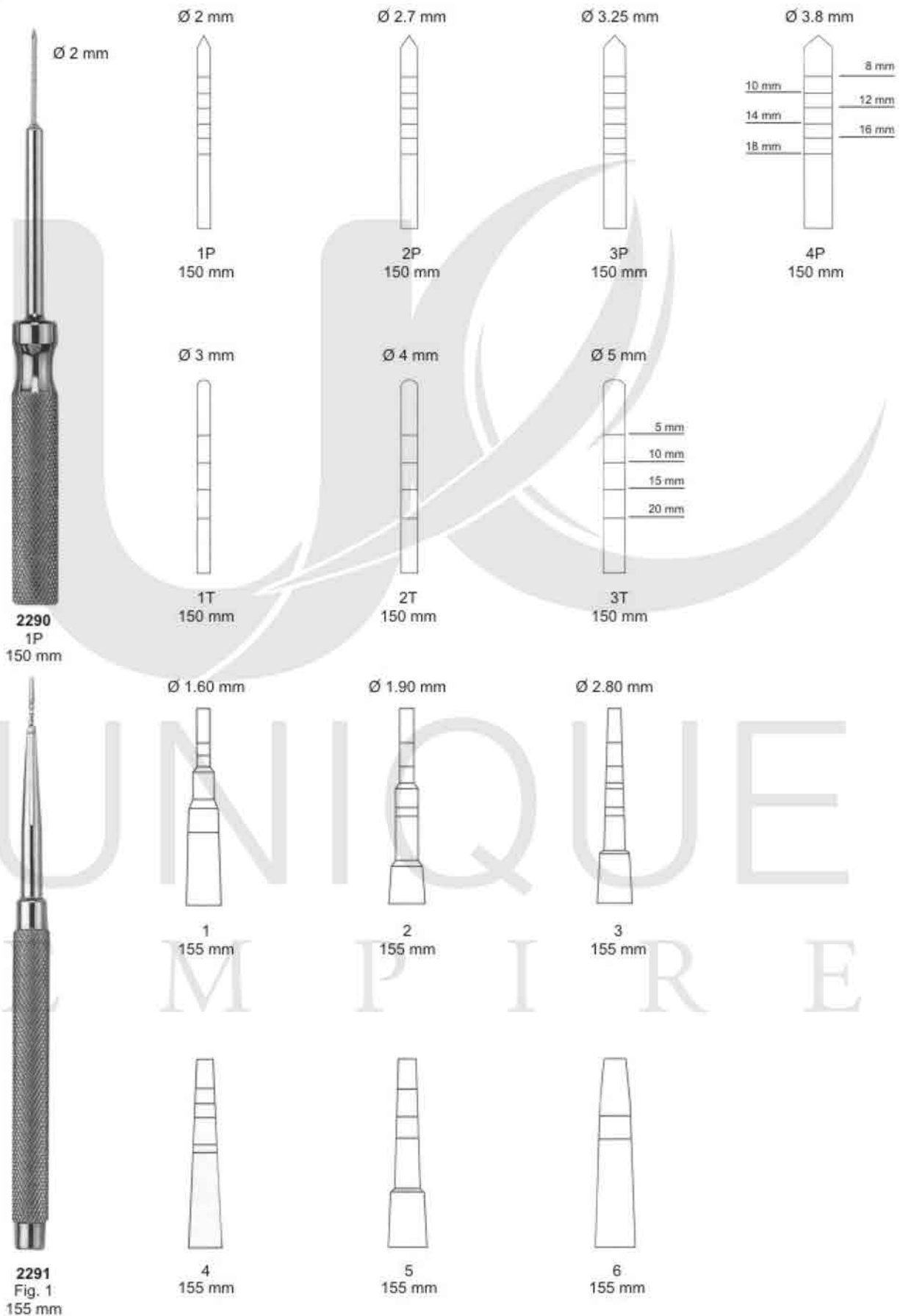



## Implants Instruments

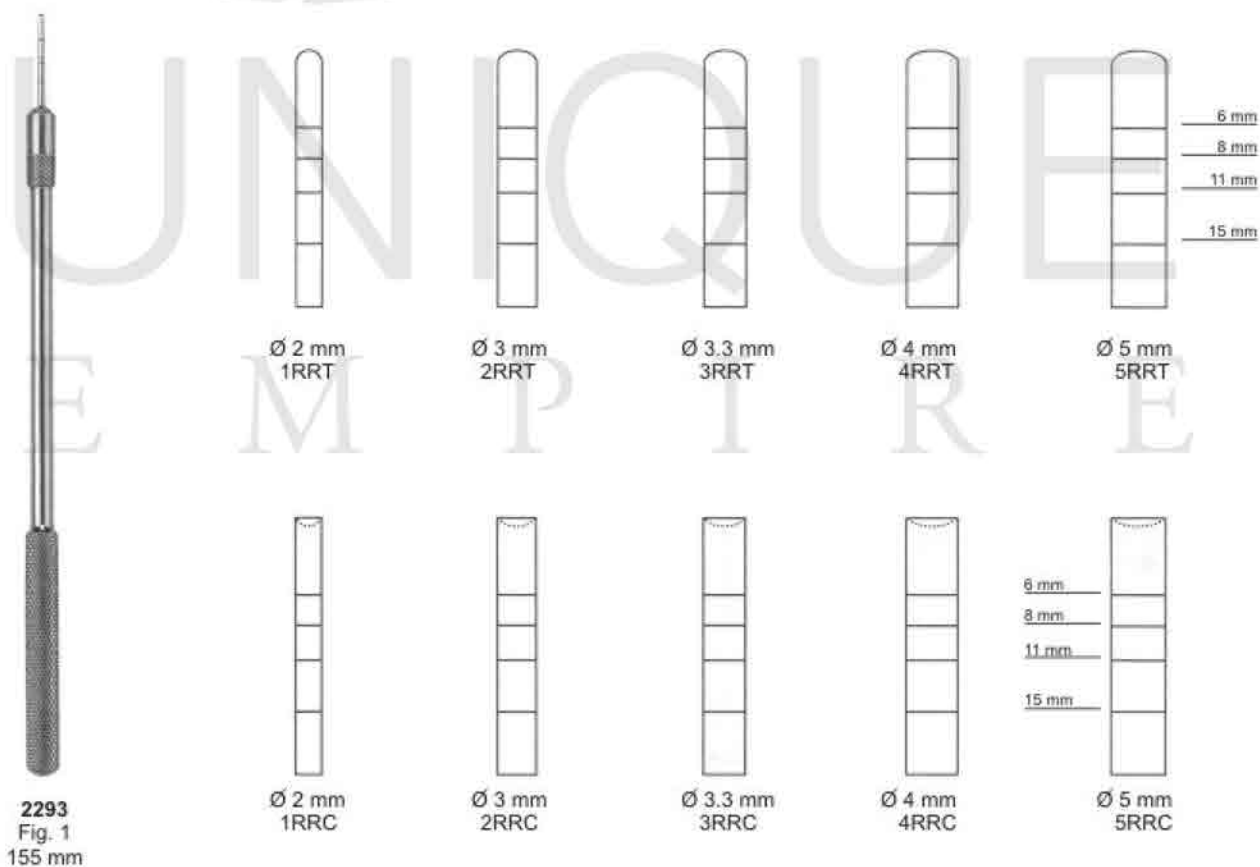
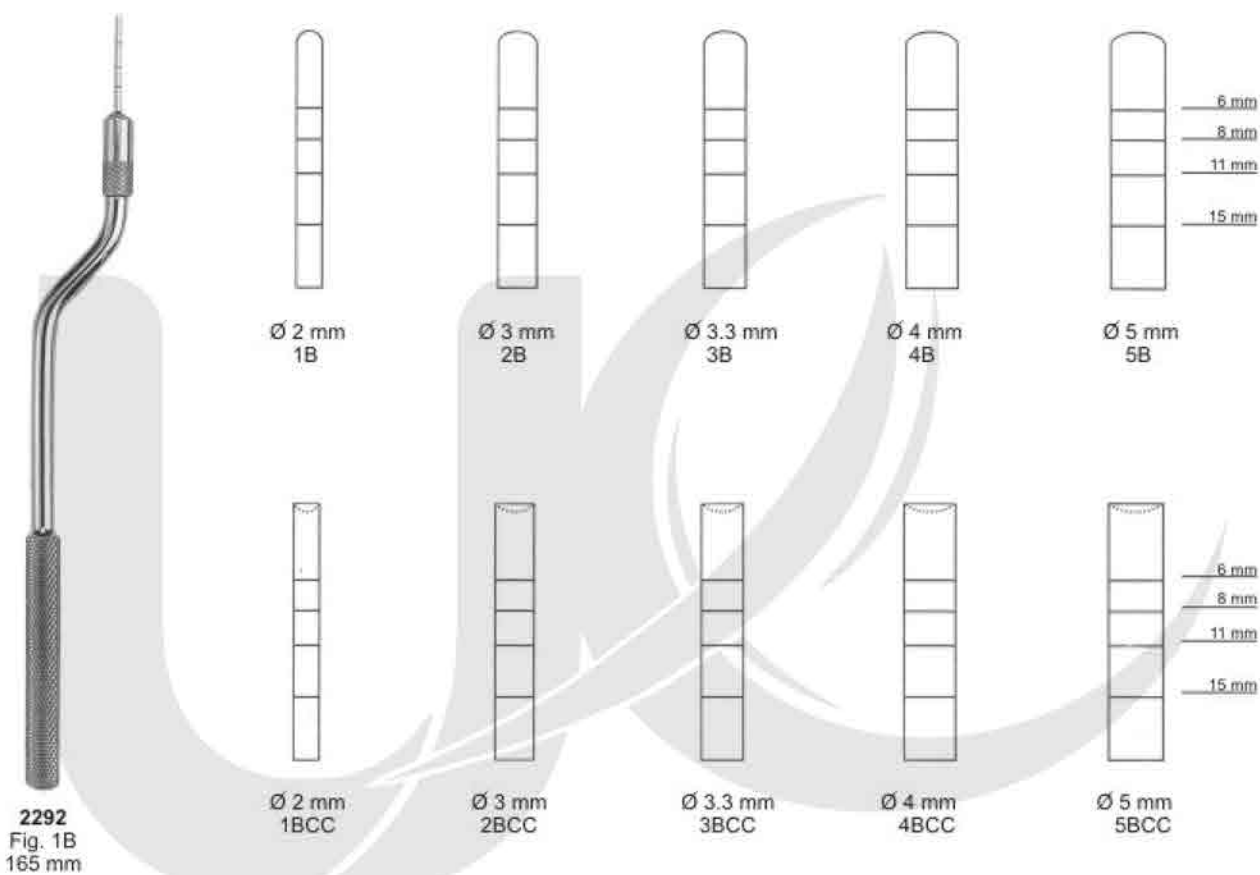



## Implants Instruments

### Endo guns for retrograds.

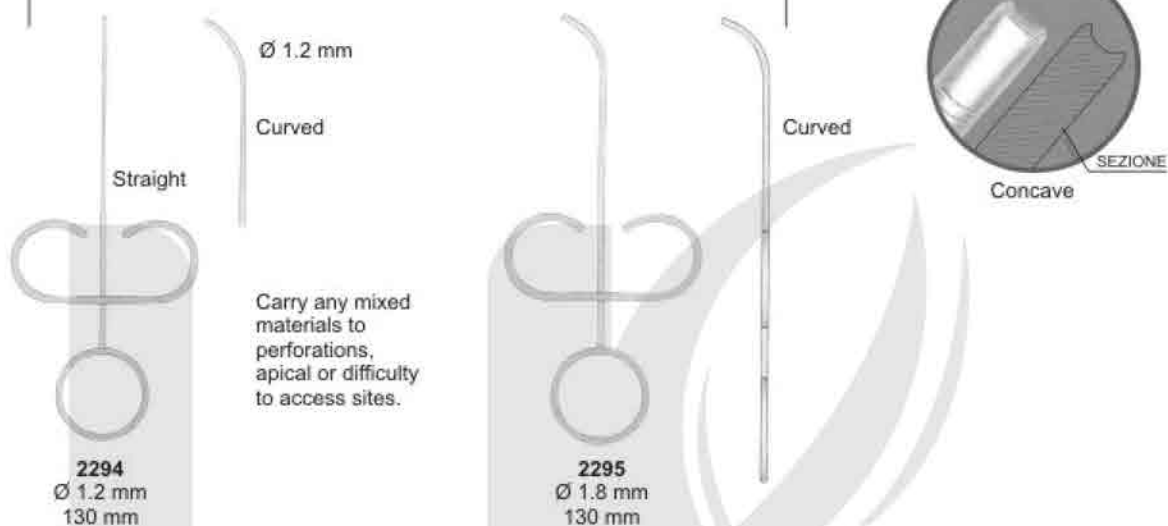

### Bone Injectors



Bone well





## Suction Tubes, Bone Pluggers & Rongeurs

### Suction Tubes



### Bone Pluggers

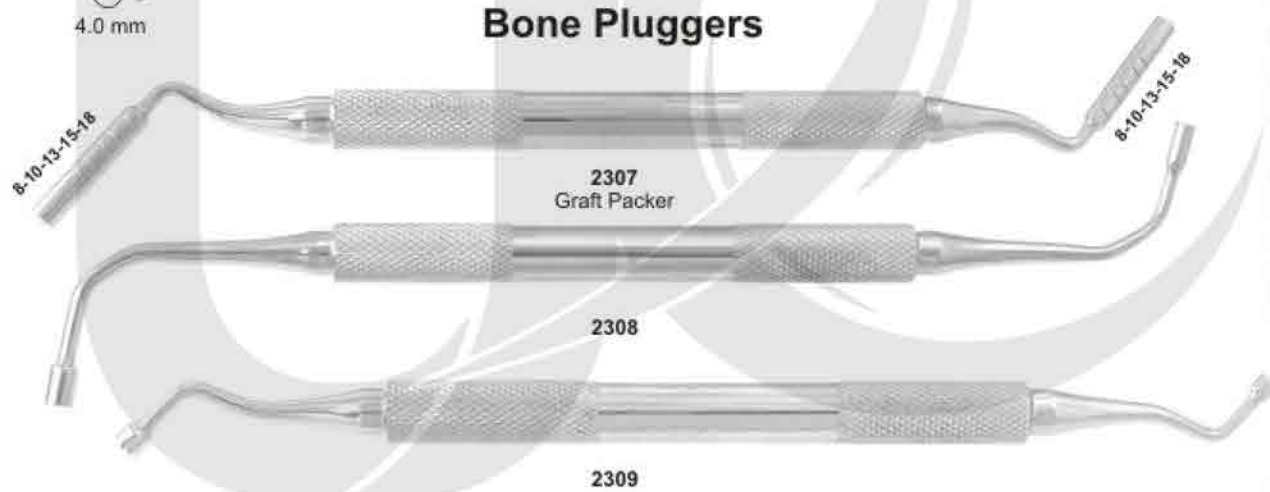

### Kerrison Rongeurs

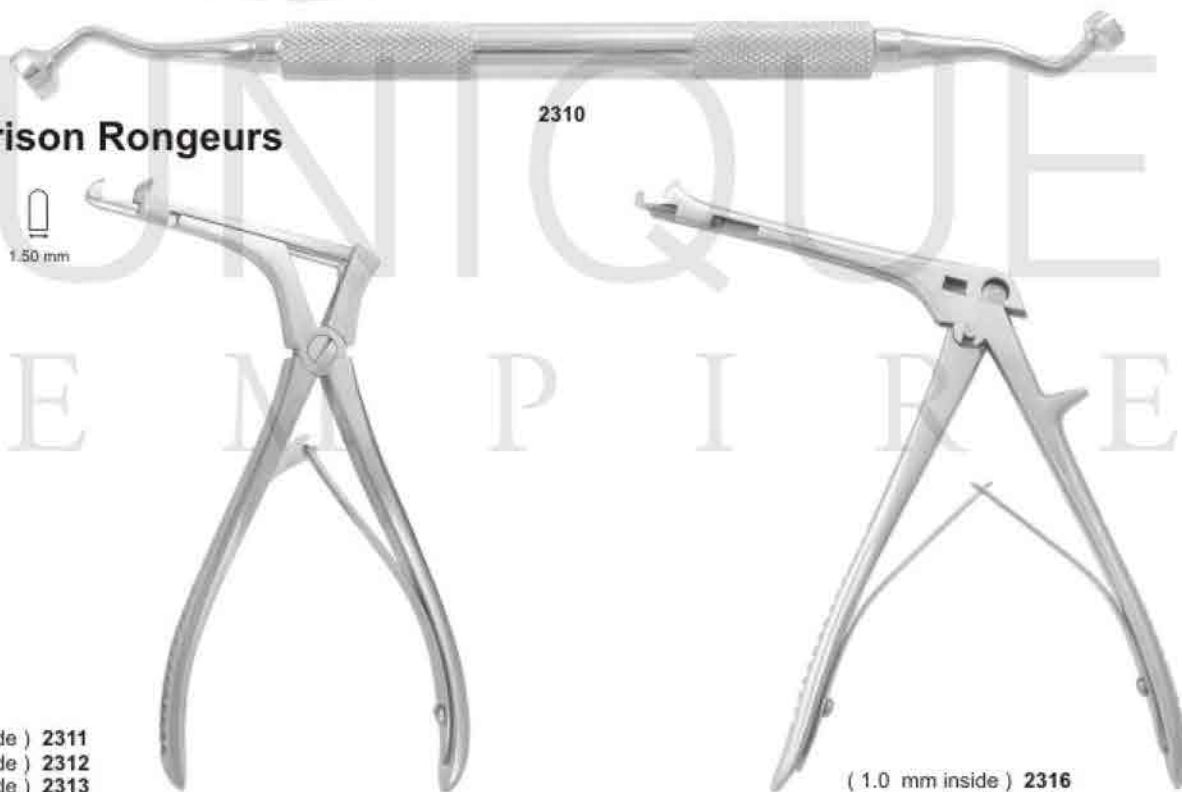

( 1.5 mm inside ) 2311  
( 2.0 mm inside ) 2312  
( 3.0 mm inside ) 2313  
( 4.0 mm inside ) 2314  
( 4.5 mm inside ) 2315  
16.5 cm

( 1.0 mm inside ) 2316  
( 2.0 mm inside ) 2317  
( 2.50 mm inside ) 2318  
16.5 cm



# Implants Instruments

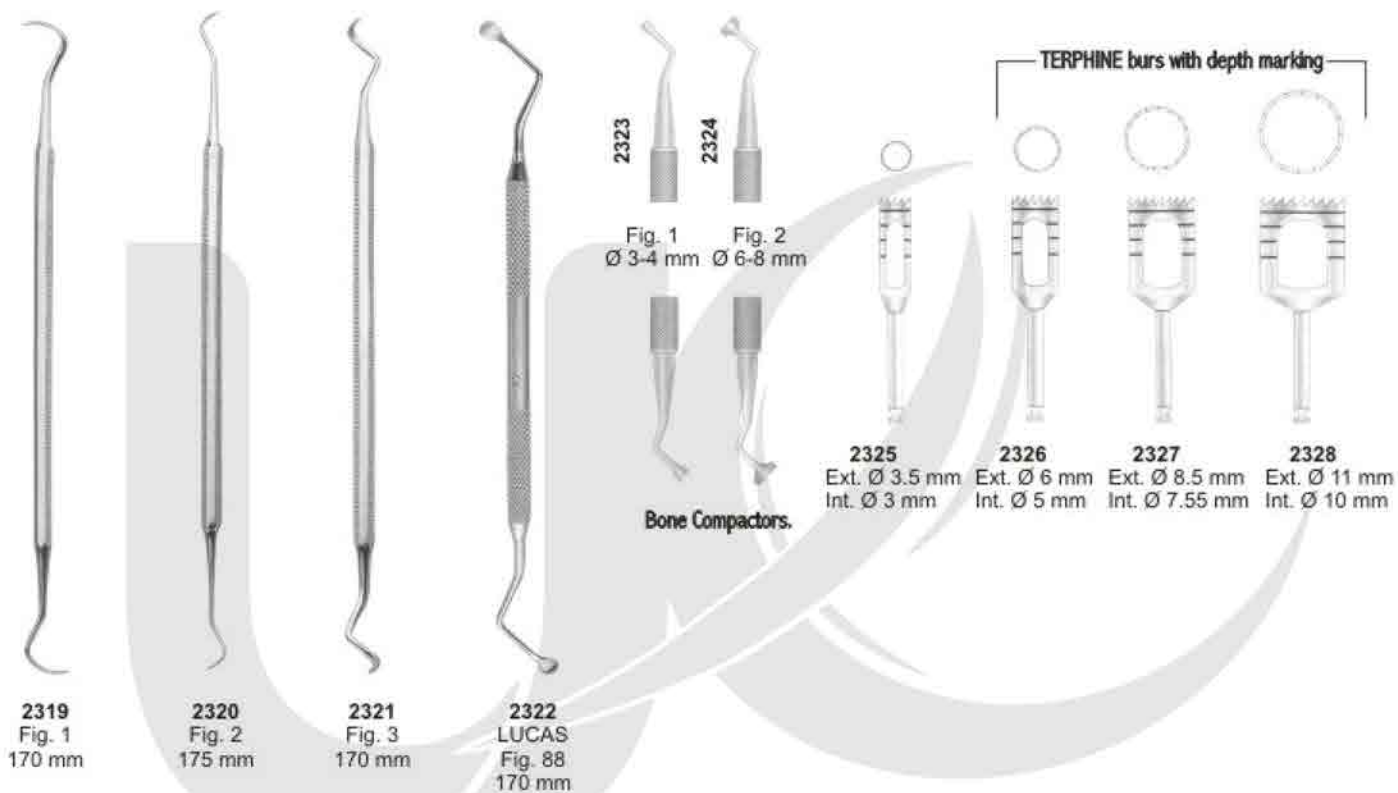

## Sinus lift instruments





## Suction Tubes

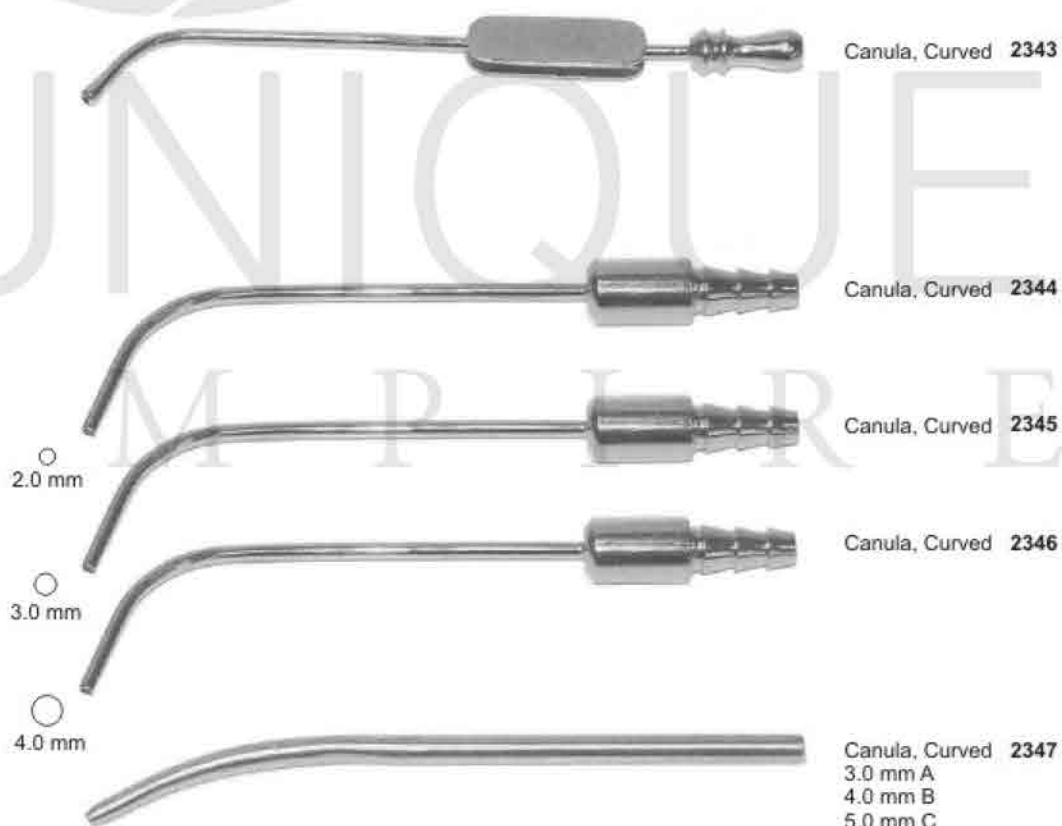



## Measuring Instruments

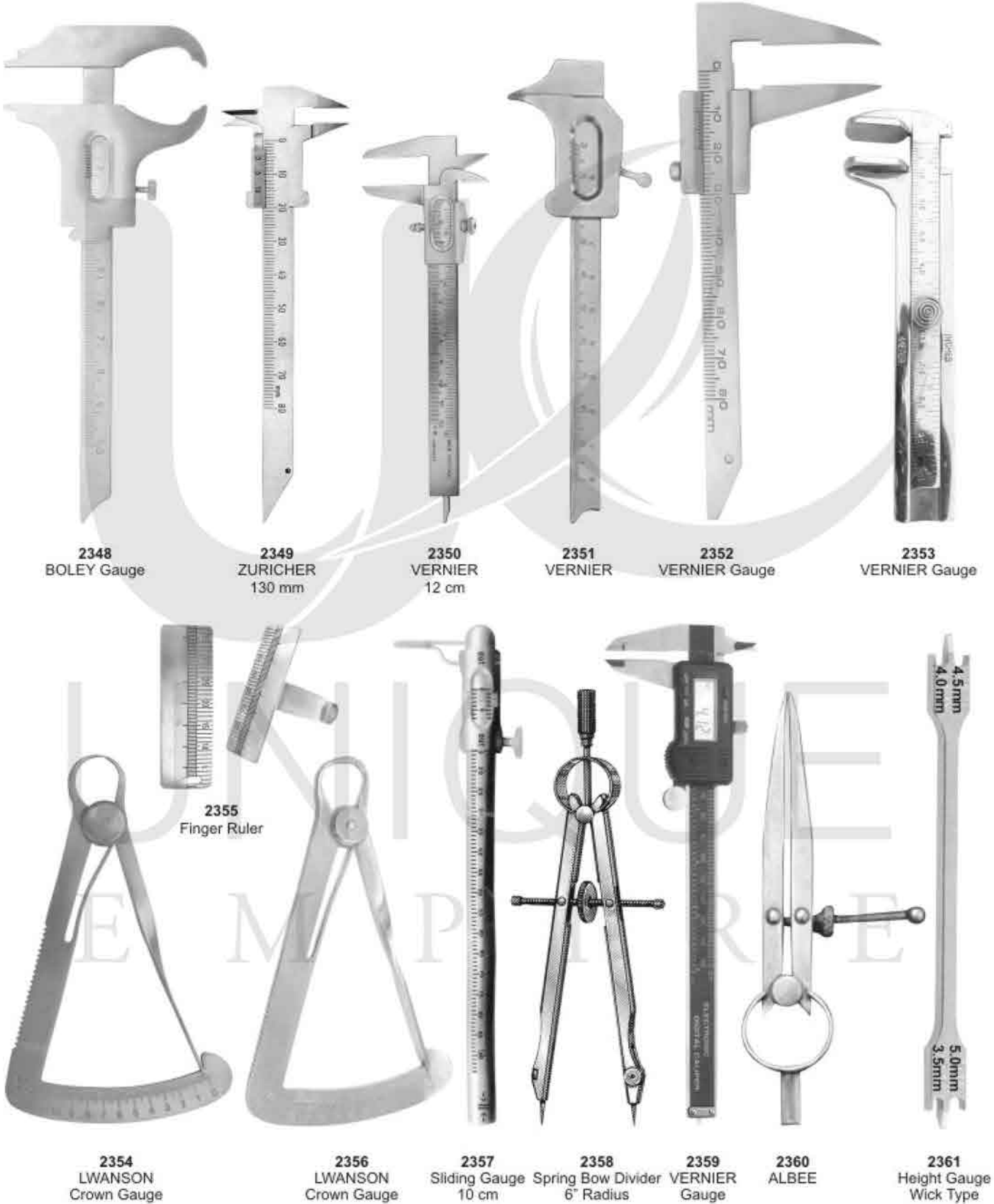





## Bone Gauge & Measuring Instruments



**2362**  
Bone Gauge



**2363**  
Bone Caliper  
15 cm



**2364**  
Castroviejo



**2365 A**  
Castroviejo  
Curved



**2365 B**  
Straight



**2366 C**  
Castroviejo  
Straight



**2366 D**  
Curved



**2367**  
Gauge



**2368**  
Castroviejo  
Straight



**2369**  
Curved



**2370 A**

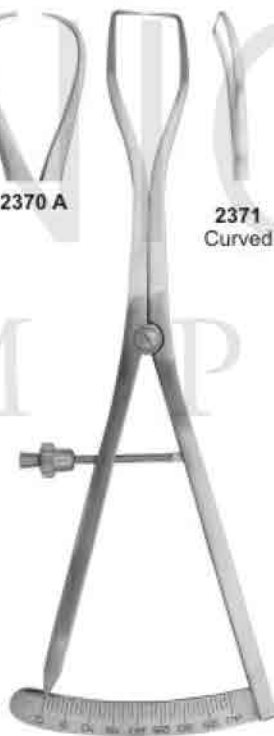

**2370**  
Castroviejo  
Straight



**2371**  
Curved



**2373**  
Boone - Gauge



**2372**  
Castroviejo



**2374**  
Curved



**2375**  
Straight



**2376**  
Bracket Gauge. Ant/Post



**UNIQUE**  
E M P I R E

SERVING HEALTH CARE WORLD WIDE



Mohalla Peeple Wala Kotli Behram,  
Sialkot - 51310 Pakistan.



+92-052-4262361



+92 302 6633155



info@uniqueempir.com



<https://www.uniqueempir.com/>



FDA CE