



SERVING HEALTH CARE WORLD WIDE

 @surgicalinstrumentssupplies

 @uniqueempiresurgical

 @unique-empire-b339b51aa

 +92 302 6633155



SURGICAL
INSTRUMENTS

[HTTPS://WWW.UNIQUEEMPIRE.COM/](https://www.uniqueempire.com/)

Punches

130° upwards cutting

15-101
1 mm



KERRISON - JACOBY

FERRIS-SMITH-KERRISON

15-102
2 mm



15-103
3 mm



15-104
4 mm



15-105
5 mm

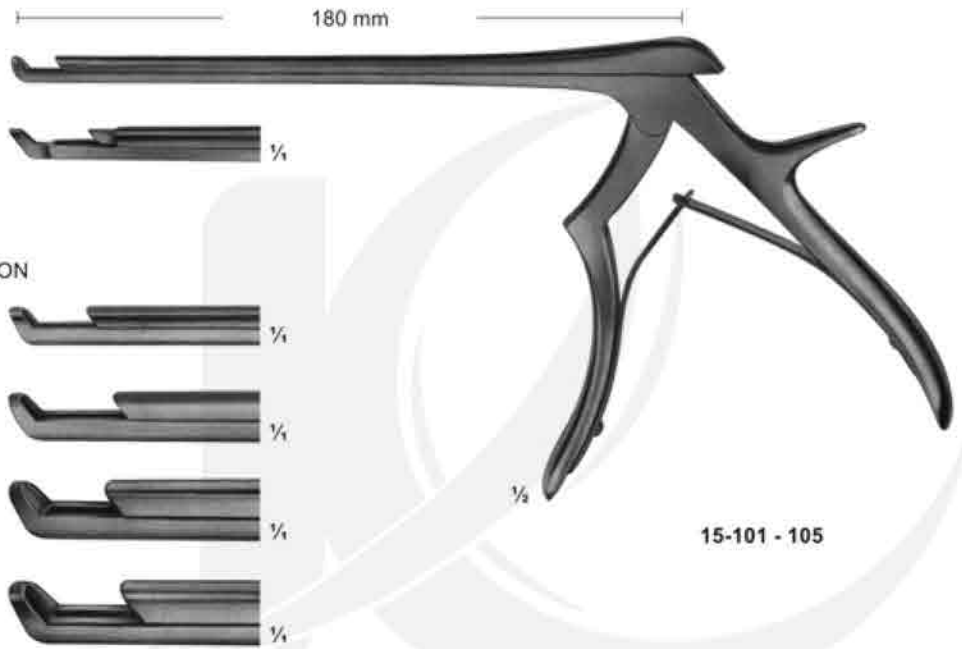

15-101 - 105

90° upwards cutting

KERRISON - JACOBY

15-106
1 mm



15-107
2 mm



FERRIS-SMITH-KERRISON

15-108
3 mm



15-109
4 mm



15-110
5 mm

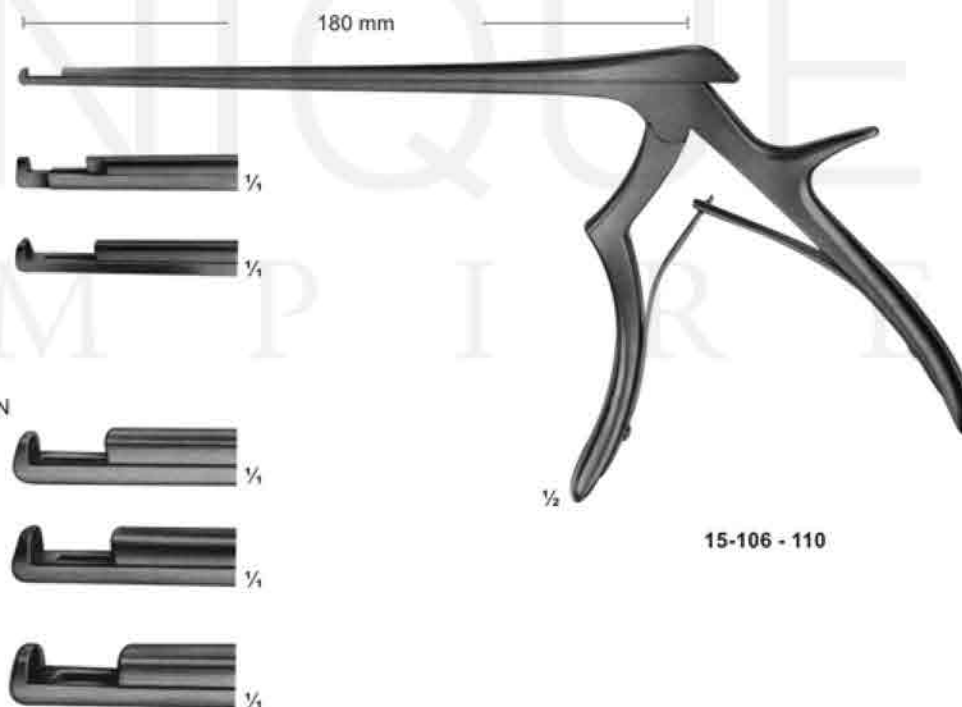

15-106 - 110

Punches

90° upwards cutting

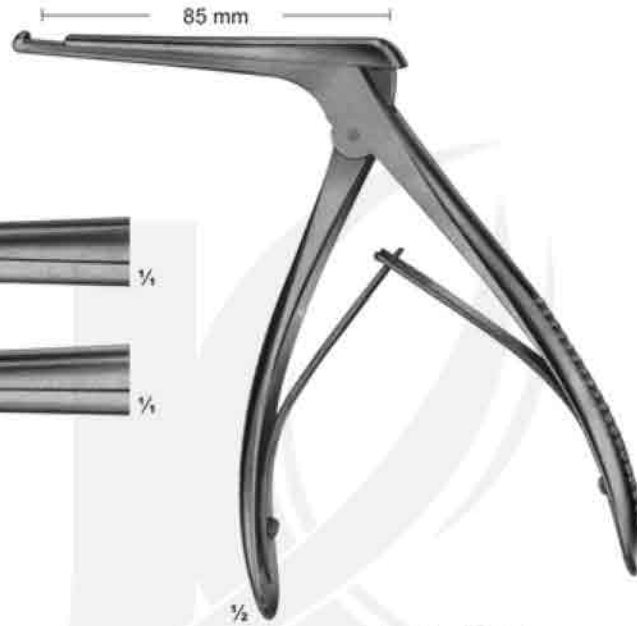

15-111
4 mm



1/4

15-112
5 mm



1/4

15-111 - 15-112
KERRISON

90° upwards cutting

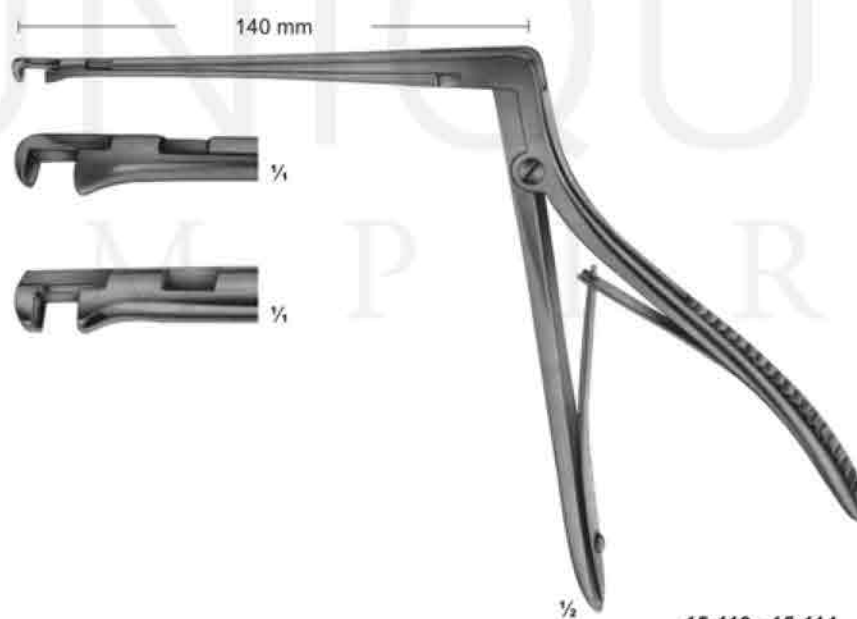

15-113
3,3 mm



1/4

15-114
4,0 mm



1/4

15-113 - 15-114
HAJEK-KOFLER

LOVE-GRUENWALD

15-115
2 X 10 mm

15-116
3 X 10 mm

SPURLING
15-117
4 X 10 mm



15-115 - 15-117

15-118
2 mm

15-119
3 mm

15-120
4 mm

15-121
5 mm



15-118 - 15-121
CASPAR

150°

15-122
2 mm

15-123
3 mm

15-124
4 mm

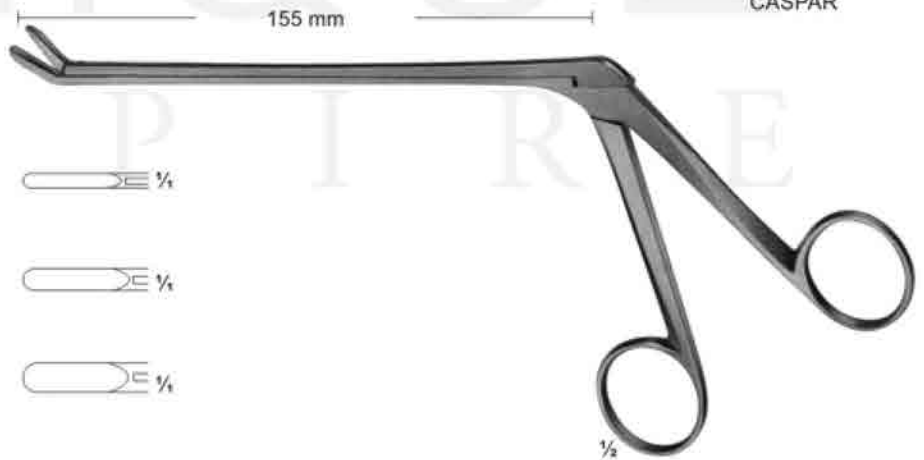

15-122 - 15-124
CASPAR

Rongeurs

Angled positions for rongeurs

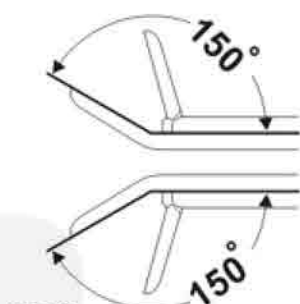

15-125
3,0 mm

15-126
3,6 mm

15-127
4,2 mm

15-128
4,8 mm

15-129
5,8 mm

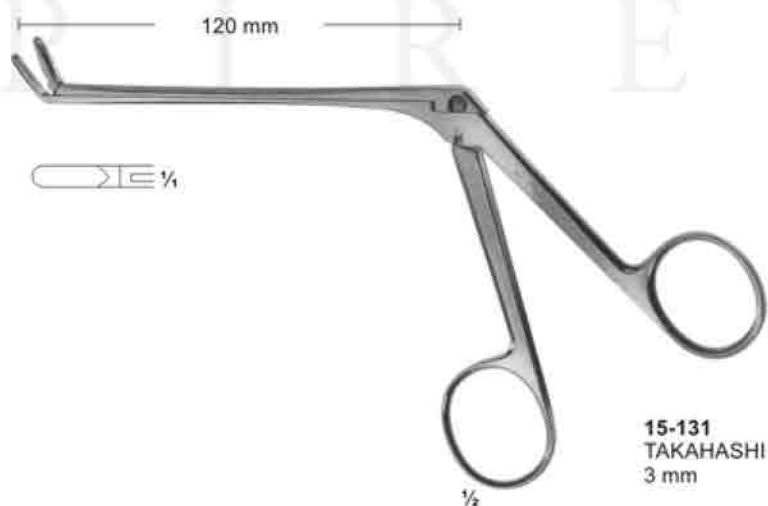
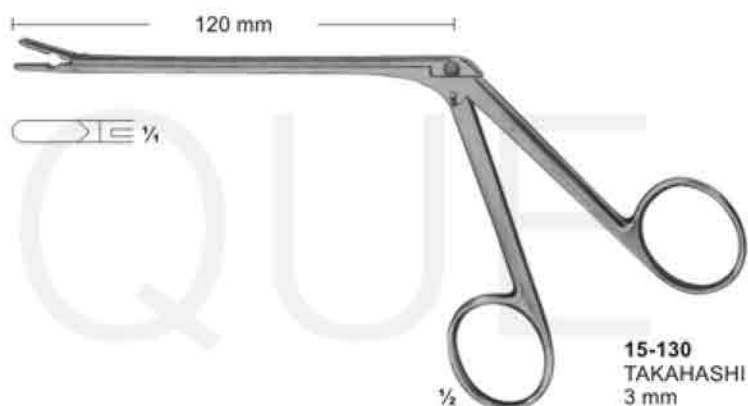
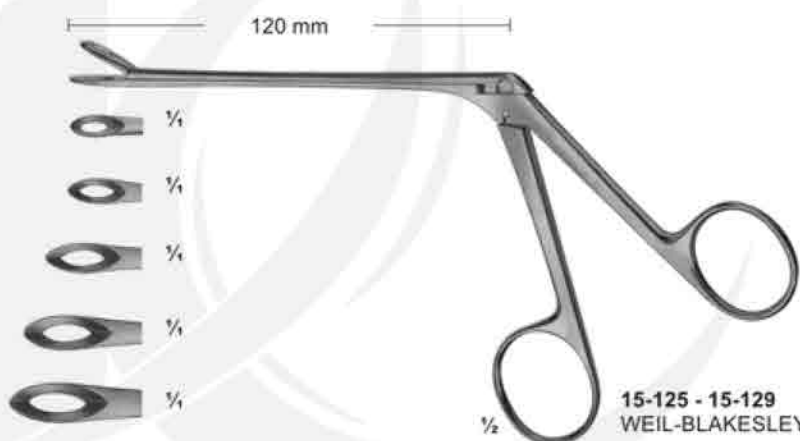
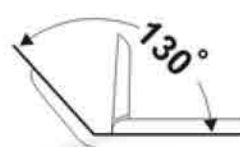
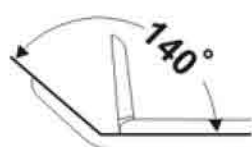

130°

Rongeurs

150°

Lower part of jaws movable



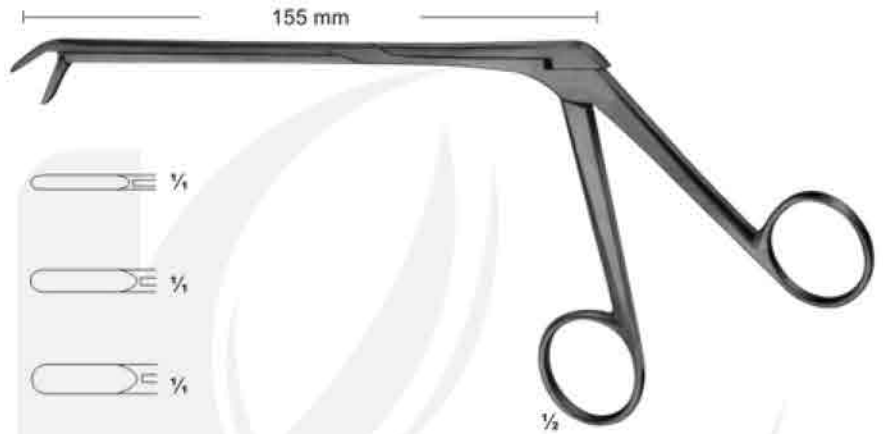

15-132
2 mm

15-133
3 mm

15-134
4 mm



15-132 - 15-134
CASPAR

| Length of shaft 140 mm | Length of shaft 160 mm | Length of shaft 185 mm | size of jaws | |
|---------------------------|---------------------------|---------------------------|--------------|------------------------------------------------------------------------------------------|
| 15-135 | 15-140 | 15-145 | 2 X12 mm |  1/4 |
| 15-136 | 15-141 | 15-146 | 3 X12 mm |  1/4 |
| 15-137 | 15-142 | 15-147 | 4 X14 mm |  1/4 |
| 15-138 | 15-143 | 15-148 | 5 X14 mm |  1/4 |
| 15-139 | 15-144 | 15-149 | 6 X16 mm |  1/4 |



15-135 - 15-149
CASPAR

150°

| Length of shaft 140 mm | Length of shaft 160 mm | Length of shaft 185 mm | size of jaws | |
|---------------------------|---------------------------|---------------------------|--------------|------------------------------------------------------------------------------------------|
| 15-150 | 15-153 | 15-156 | 3 X12 mm |  1/4 |
| 15-151 | 15-154 | 15-157 | 4 X14 mm |  1/4 |
| 15-152 | 15-155 | 15-158 | 5 X14 mm |  1/4 |

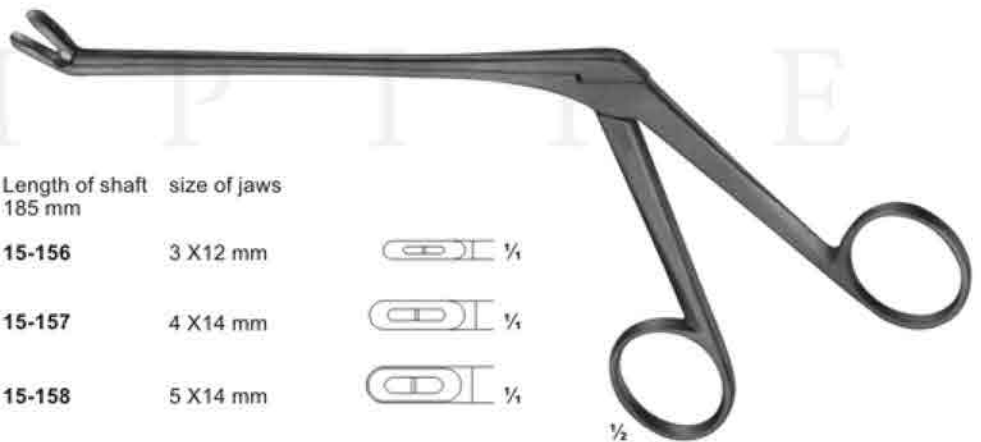

15-150 - 15-158
CASPAR

Rongeurs

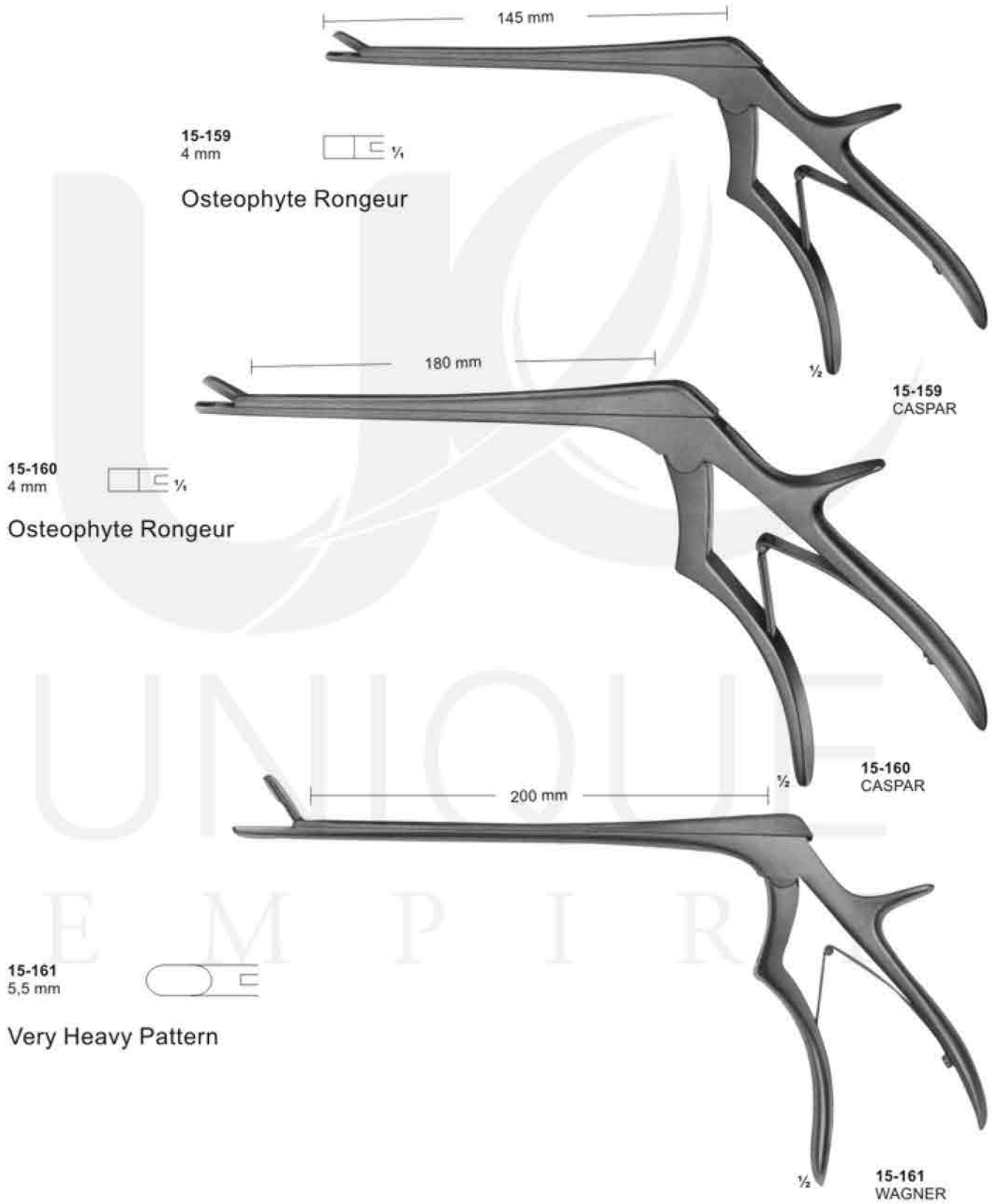



SERVING HEALTH CARE WORLD WIDE



Mohalla Peeple Wala Kotli Behram,
Sialkot - 51310 Pakistan.



+92-052-4262361



+92 302 6633155



info@uniqueempir.com



<https://www.uniqueempir.com/>



FDA CE