



SERVING HEALTH CARE WORLD WIDE

 @surgicalinstrumentssupplies

 @uniqueempiresurgical

 @unique-empire-b339b51aa

 +92 302 6633155



SURGICAL
INSTRUMENTS

[HTTPS://WWW.UNIQUEEMPIRE.COM/](https://www.uniqueempire.com/)

Wire Extension

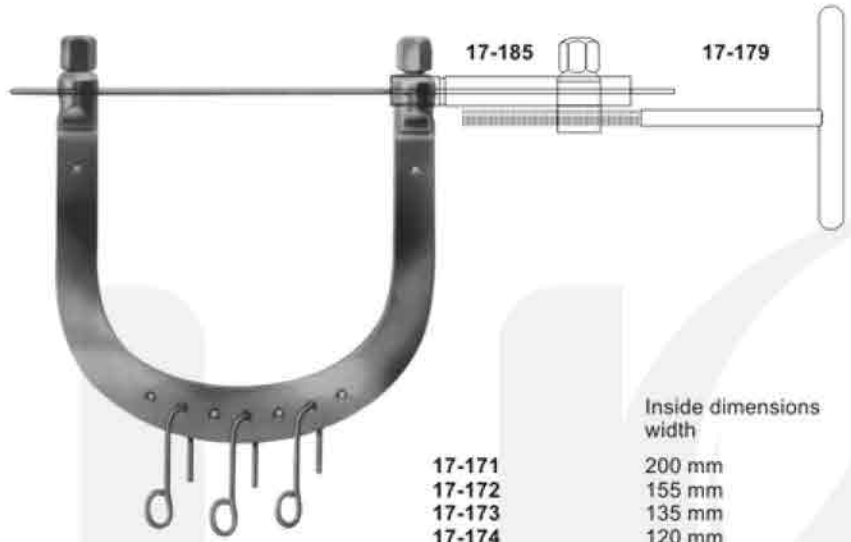

17-171 - 17-177
KIRSCHNER
 Wire traction bows,
 to be used with
 KIRSCHNER-wires
 up to 2.5 mm diam.,
 With 3 hooks,
 stainless steel

	Inside dimensions width	depth	
17-171	200 mm	155 mm	for the hip
17-172	155 mm	155 mm	for the femur
17-173	135 mm	130 mm	for the knee
17-174	120 mm	120 mm	for the knee
17-175	105 mm	100 mm	for the knee
17-176	95 mm	110 mm	for the calcaneus
17-177	95 mm	70 mm	for the arm and elbow



17-178
 Wrench, double - ended,
 for wire traction bows



17-179
 Wire tightener, with
 clamping jaws



17-182	max. 105 mm
17-183	max. 160 mm
17-184	max. 200 mm
17-182	80-95 mm
17-183	90-120 mm
17-184	140-170 mm
diam upto	
17-182	1,6 mm
17-183	2,0 mm
17-184	2,5 mm

17-182 - 17-184
KIRSCHNER
 Wire traction bows, modified,
 adjustable in width, holds wire
 securely, with 1 hook



17-180
 Traction hook only,
 large size



17-181
 Traction hook only,
 small size



17-185
 Fixation clamp, to secure clamping
 jaws of 17-179 stainless steel

Cerclage Instruments

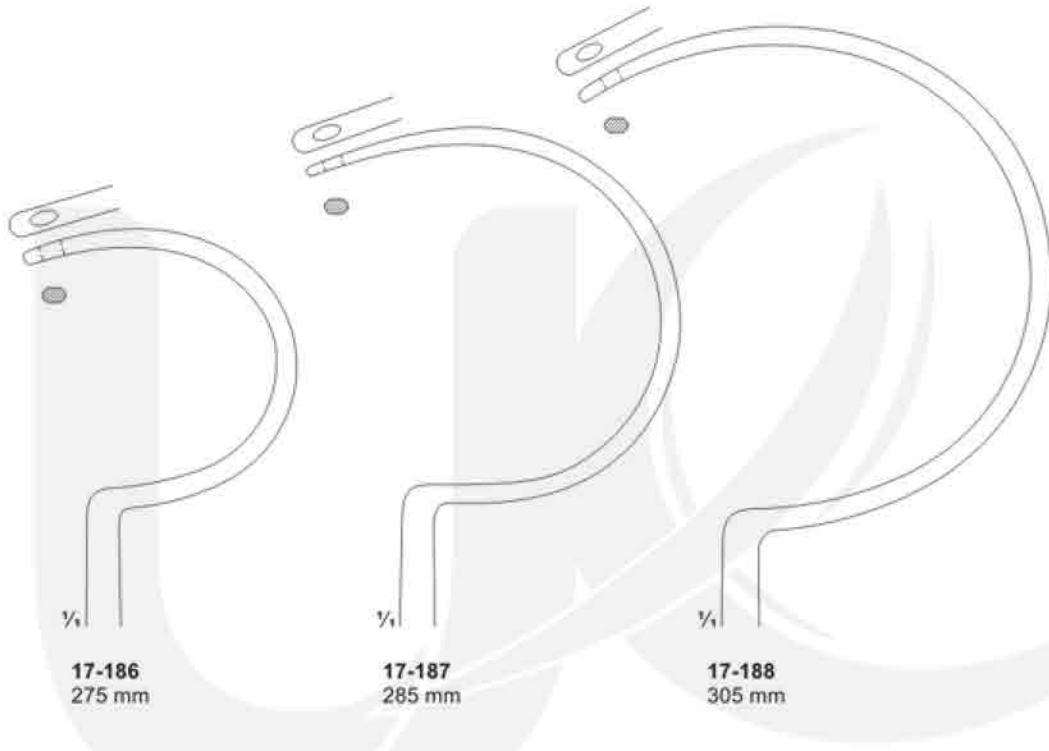

17-186
275 mm

17-187
285 mm

17-188
305 mm



17-186 - 17-188
DEMEL
Wire guides

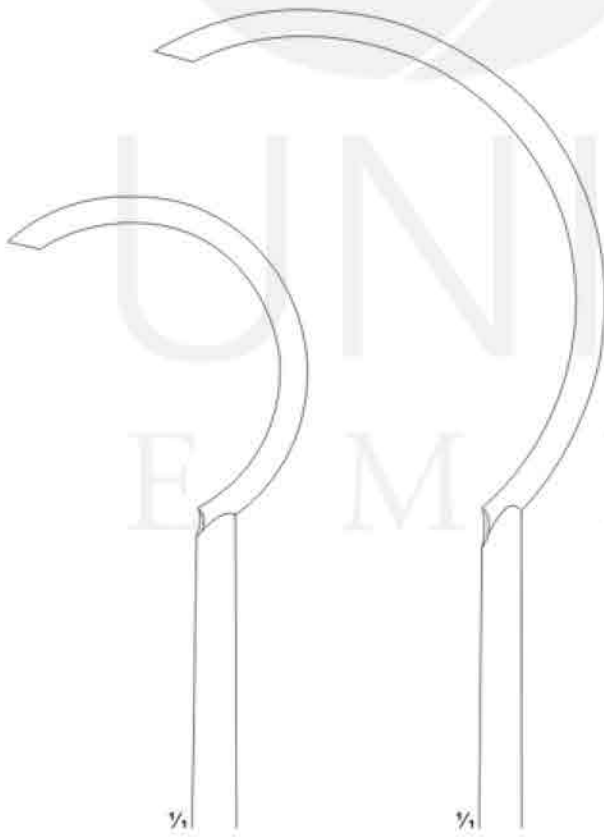

17-189
240 mm

17-190
270 mm

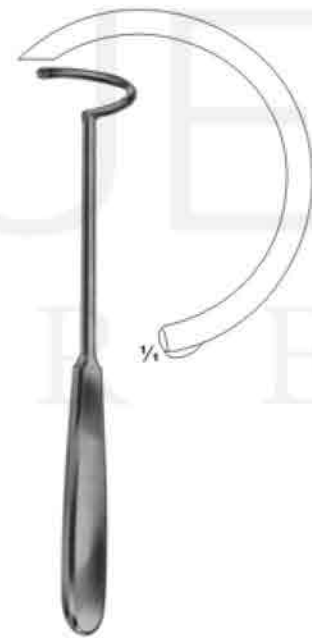

17-191
225 mm

Wire Holding forceps, Wire Tightening Pliers, Flat-nosed Pliers DUROGRIP with Hard Metal Inserts



17-192
DUROGRIP
Holding forceps for cerclage
wire, with lateral jaws to avoid
wire slipping off
170 mm



17-193
DUROGRIP
Wire, tightening pliers,
Ligature pliers
150 mm



17-194
DUROGRIP
Wire, tightening pliers,
Ligature pliers
150 mm



17-195
with serrated jaws
140 mm



17-196
one jaw smooth,
one jaw serrated
140 mm



17-197
with serrated jaws
17-198
with longitudinal and
transversal grooves
170 mm



17-199
190 mm

Wire Holding forceps, Flat-nosed Pliers, Pliers for bending and cutting wires

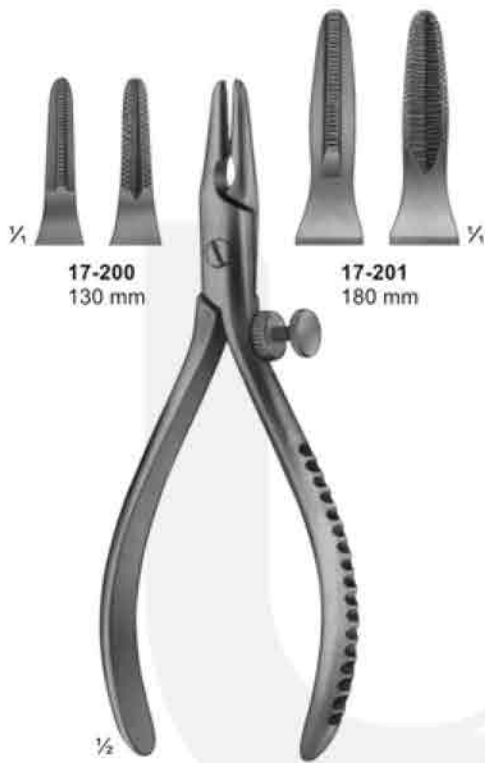

17-200 - 17-201
Extraction pliers
for boring wires



17-202
Flat-nosed pliers,
parallel
185 mm

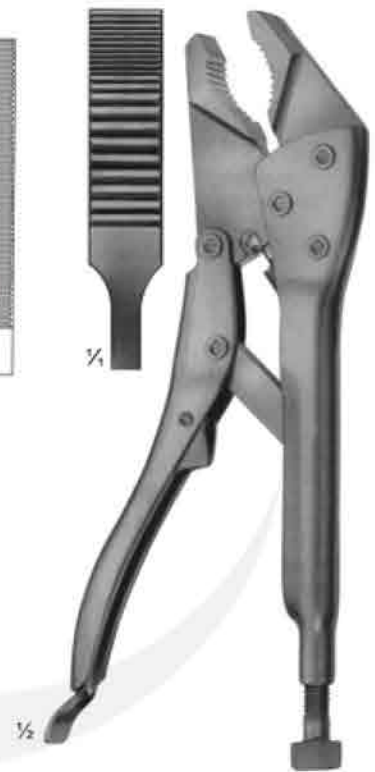

17-203
Vise grip
200 mm



17-204
Round Pliers
180mm

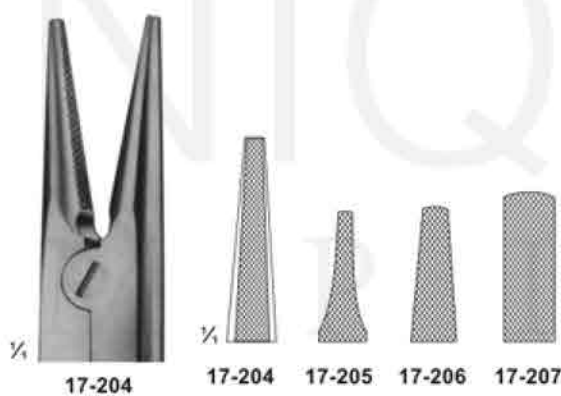

17-205 145 mm
17-206 180 mm
17-207 180 mm
Extraction pliers for wires



17-208
Bending pliers
for wires up to
1.8 mm diam.

Wire Cutters and wire Cutting Scissors DUROTIP with Carbide Cutting Edges



17-209
ANGLE
130 mm

17-210
DUROTIP
ANGLE
130 mm

17-211
120 mm

17-212
DUROTIP
120 mm

17-213
HARVEY
125 mm

for soft wire
up to diam.
for hard wire
up to diam.

0,5 mm
0,3 mm

0,6 mm
0,4 mm

for soft wire
up to diam.
for hard wire
up to diam.

1,2 mm
0,8 mm

1,2 mm
0,8 mm

0,4 mm
0,3 mm



17-214
150 mm

17-215
160 mm

17-216
140 mm
DUROTIP
1,5 mm

for soft wire
up to diam
for hard wire
up to diam

1,5 mm
1,0 mm

1,5 mm
1,2 mm

1,0 mm

Wire Cutting Pliers, Lateral Cutting Action

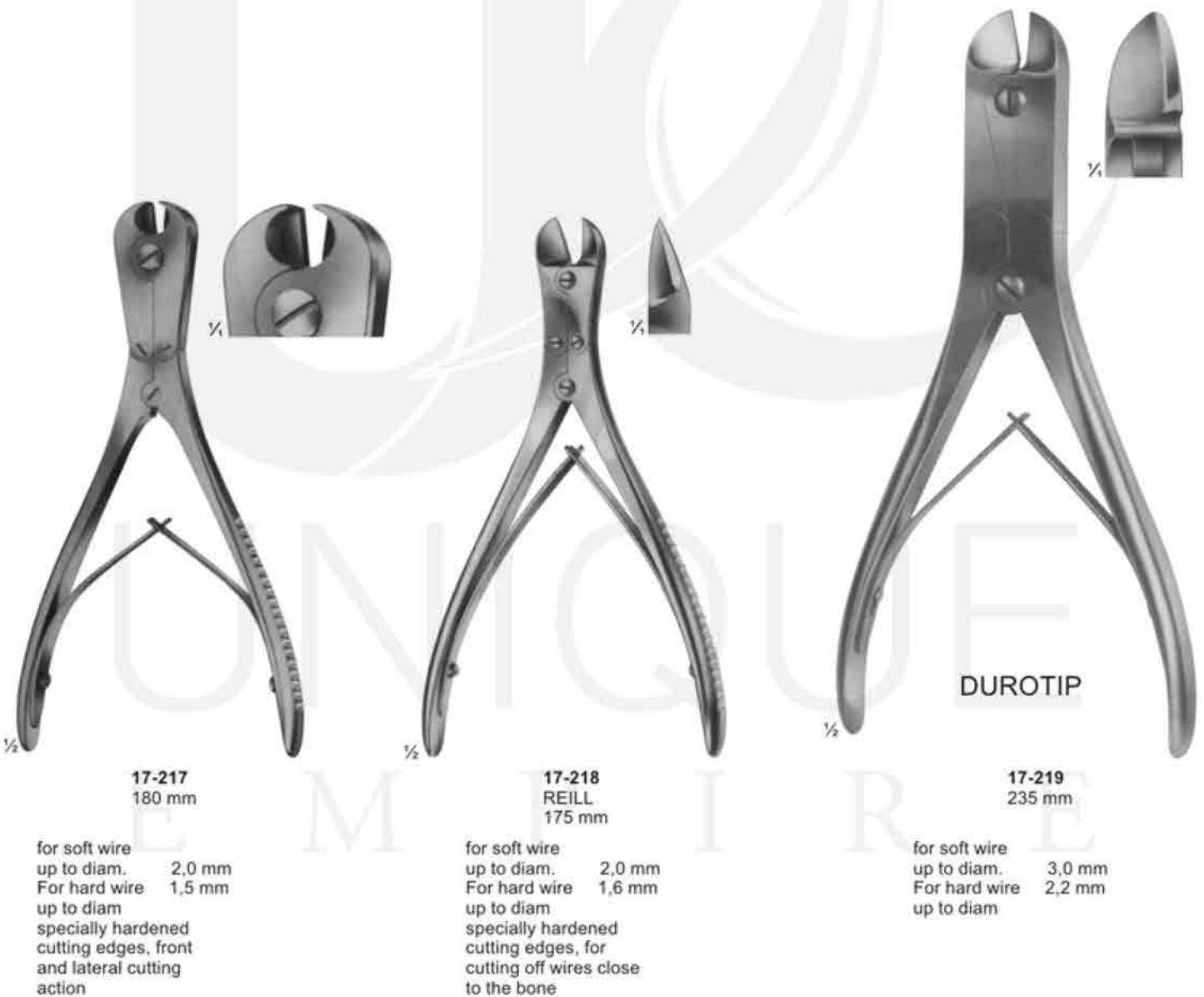

Wire Cutting Pliers, Lateral and Front Cutting Action



specially hardened cutting edges

Durotip

Durotip

Durotip

Durotip

Model	Length	Soft wire capacity	Hard wire capacity
17-220	240 mm	up to diam. 2,0 mm	up to diam. 1,6 mm
17-221	145 mm	up to diam. 1,5 mm	up to diam. 1,0 mm
17-222	145 mm	up to diam. 2,0 mm	up to diam. 1,5 mm
17-223	220 mm	up to diam. 3,5 mm	up to diam. 2,5 mm

Wire Cutting Pliers



Cutter for cutting off
KIRSCHNER wires,
Tibia head screws,
bolts, pins, up to 3 mm diam.

17-224
320 mm

for soft wire
up to diam. 3,0 mm
For hard wire
up to diam. 3,0 mm

DUROTIP

17-225
Cutter for cutting off
KIRSCHNER wires,
Tibia head screws,
bolts, pins, up to 6 mm diam.
470 mm

Finger Nail Instruments

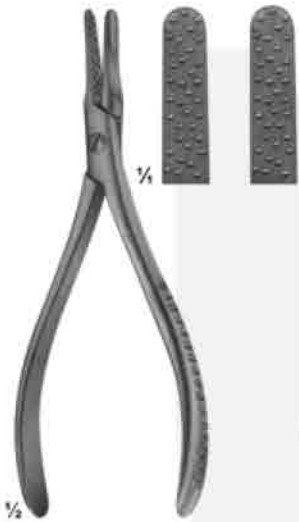

17-226
Nail extracting
forceps
135 mm



17-227
Nail extracting
forceps
145 mm



17-228
Finger nail drill
with 3 drill points

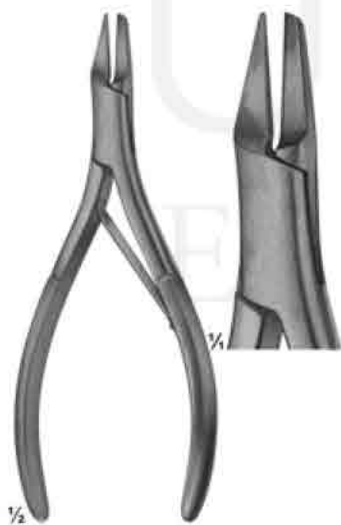

17-231
Nail splitting
forceps
135 mm



17-232
SYSTRUNK
Scissors, for splitting
finger nails
130 mm



17-233
Finger ring saw
150 mm



Plaster Shears



17-235
STILLE-AESCULAP
260 mm

17-236
STILLE-AESCULAP
360 mm

Plaster Spreader, Plaster Breakers



17-237
HENING
270 mm



17-238
MOD.USA
230 mm



17-239
290 mm



with removable jaws



17-240 - 17-241
WOLFF
17-240 180 mm
17-241 240 mm
plaster breakers



UNIQUE
E M P I R E

SERVING HEALTH CARE WORLD WIDE



**Mohalla Peeple Wala Kotli Behram,
Sialkot - 51310 Pakistan.**



+92-052-4262361



+92 302 6633155



info@uniqueempir.com



<https://www.uniqueempir.com/>



FDA CE